

Stefano Orlati Titus+



Stefano Orlati Cabinet Handles 2018 Catalogue

Stefano Orlati Titus+

Cabinet Handles

Product Guide

Stefano Orlati Handles















	Page
Information	3
Bow Handles	4
Profile Handles	14
Provincial Handles	23
Recessed Handles	27
Square Handles	29
Stainless Steel Handles	42
Knobs	45











Stefano Orlati Handles

Information

Colour Finish Guide

Please note: Colour finish guide is indicative only - actual finish may vary

AB		Antique Bronze
ABS		Aluminium Brushed Satin
AC		Antique Copper
AI		Antique Iron
BLKN		Black Nickel
BN		Brushed Nickel
BSAT		Brushed Satin Antique Tin
BSBN		Brushed Satin Black Nickel
CH		Chrome
CL		Clear Glass
FS		Foggy Silver
G		Gold
MAB		Matt Antique Brass
MB		Matt Black

MBN		Matt Brushed Nickel
MC		Matt Chrome
MW		Matt White
P		Pewter
PB		Polished Brass
PCO		Polished Copper
S		Silver
SB		Satin Brass
SC		Satin Chrome
SN		Satin Nickel
SS		Stainless Steel
TG		Titanium Grey
WH		White

Guide to Handle Dimensions

Length: Overall length of the handle (mm)

Centre: Screw hole to screw hole (mm)

Height: Height/Projection of handle (mm)

Width: Width of handle face (mm)

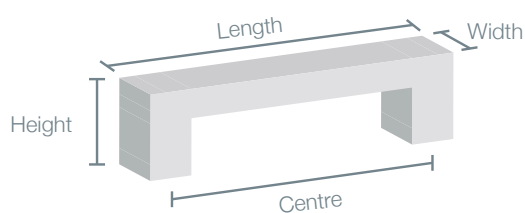

*All colours are for representation purposes only.
For an exact colour match, ensure you request a sample.*

Bow Handles

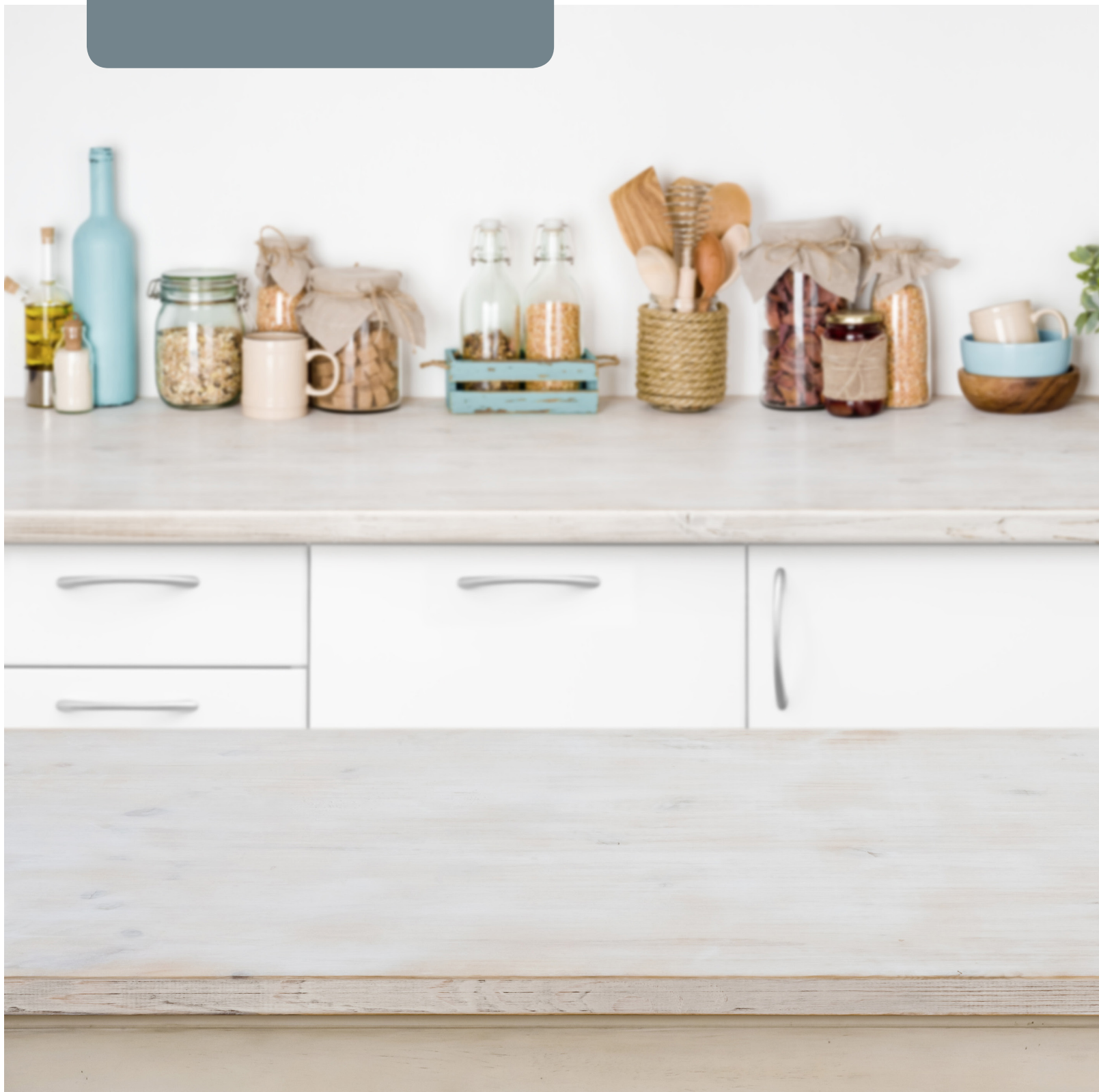



Stefano Orlati Handles

Bow Handles

	Centre (mm)	Length (mm)	Height (mm)	Width (mm)	Item number	Finish
112 	128	170	27	24	SO-112-128 →	BN
	128	170	27	24	SO-112-128 →	MC
114 	160	185	27	24	SO-114-160 →	BN
	160	185	27	24	SO-114-160 →	MC
122 	160	180	26	18	SO-122-160 →	BN
	160	180	26	18	SO-122-160 →	MC



Stefano Orlati Handles

Bow Handles

	Centre (mm)	Length (mm)	Height (mm)	Width (mm)	Item number	Finish
311 	128	165	31	16	SO-311-128 →	BN
325 	128	168	29	12	SO-325-128 →	CH
	160	200	29	12	SO-325-160 →	CH
	224	264	30	12	SO-325-224 →	CH
	320	360	30	12	SO-325-320 →	CH
	128	168	29	12	SO-325-128 →	SN
	160	200	29	12	SO-325-160 →	SN
	224	264	30	12	SO-325-224 →	SN
	320	360	30	12	SO-325-320 →	SN
	128	168	29	12	SO-325-128 →	PCO
	160	200	29	12	SO-325-160 →	PCO
	224	264	30	12	SO-325-224 →	PCO
	320	360	30	12	SO-325-320 →	PCO
	688 	96	124	12	26	SO-688-96 →

Stefano Orlati Handles

Bow Handles

	Centre (mm)	Length (mm)	Height (mm)	Width (mm)	Item number	Finish
1037 	128	158	29	10	SO-1037-128 →	BN
	128	158	29	10	SO-1037-128 →	MC
	128	158	29	10	SO-1037-128 →	CH
	128	158	29	10	SO-1037-128 →	PB
	128	158	29	10	SO-1037-128 →	SB
1062 	96	143	24	14	SO-2060-96 →	BN
	128	183	26	16	SO-2060-128 →	BN
	96	143	24	14	SO-2060-96 →	MC
	128	183	26	16	SO-2060-128 →	MC

Stefano Orlati Handles

Bow Handles

	Centre (mm)	Length (mm)	Height (mm)	Width (mm)	Item number	Finish
2060 	96	115	28	10	SO-2060-96 →	BN
	128	154	30	10	SO-2060-128 →	BN
	96	115	28	10	SO-2060-96 →	MC
	128	154	30	10	SO-2060-128 →	MC
2188 	96	121	29	20	SO-2188-96 →	BN
	96	121	29	20	SO-2188-96 →	MC
3062 	160	222	28	26	SO-3062-160 →	BN

Stefano Orlati Handles

Bow Handles

	Centre (mm)	Length (mm)	Height (mm)	Width (mm)	Item number	Finish
3130 	128	147	30	18	SO-3130-128 →	BN
	192	222	30	18	SO-3130-192 →	BN
	256	275	30	18	SO-3130-256 →	BN
	416	430	30	18	SO-3130-416 →	BN
	128	147	30	18	SO-3130-128 →	MB
	192	222	30	18	SO-3130-192 →	MB
	256	275	30	18	SO-3130-256 →	MB
	416	430	30	18	SO-3130-416 →	MB
	128	147	30	18	SO-3130-128 →	WH
	192	222	30	18	SO-3130-192 →	WH
	256	275	30	18	SO-3130-256 →	WH
	416	430	30	18	SO-3130-416 →	WH
3319 	96	140	22	15	SO-3319-96 →	BN
	192	250	22	15	SO-3319-192 →	BN
	96	140	22	15	SO-3319-96 →	MC
	192	250	22	15	SO-3319-192 →	MC

Stefano Orlati Handles

Bow Handles

	Centre (mm)	Length (mm)	Height (mm)	Width (mm)	Item number	Finish
3380 	128	151	28	25	SO-3380-128 →	BN
	160	189	28	25	SO-3380-160 →	BN
	224	260	33	25	SO-3380-224 →	BN
	320	358	33	25	SO-3380-320 →	BN
	416	463	38	25	SO-3380-416 →	BN
	128	151	28	25	SO-3380-128 →	TG
	160	151	28	25	SO-3380-160 →	TG
	224	260	33	25	SO-3380-224 →	TG
	320	358	33	25	SO-3380-320 →	TG
	416	463	33	25	SO-3380-416 →	TG
6329 	128	167	26	22	SO-6329-128 →	MB
	192	231	26	22	SO-6329-192 →	MB
	256	295	26	22	SO-6329-256 →	MB
	320	359	27	22	SO-6329-320 →	MB
	128	167	26	22	SO-6329-128 →	MBN
	192	231	26	22	SO-6329-192 →	MBN
	256	295	26	22	SO-6329-256 →	MBN
	320	359	27	22	SO-6329-320 →	MBN

Stefano Orlati Handles

Bow Handles

	Centre (mm)	Length (mm)	Height (mm)	Width (mm)	Item number	Finish
7025 	128	138	25	20	SO-7025-128 →	BN
	160	170	28	20	SO-7025-160 →	BN
	224	234	28	20	SO-7025-224 →	BN
	320	330	28	20	SO-7025-320 →	BN
	128	138	25	20	SO-7025-128 →	MC
	160	170	28	20	SO-7025-160 →	MC
	224	234	28	20	SO-7025-224 →	MC
	320	330	28	20	SO-7025-320 →	MC
9238 	96	118	25	12	SO-9238-96 →	SN
9718 	96	141	30	9	SO-9718-96 →	BN
	128	200	30	12	SO-9718-128 →	BN
	96	141	30	9	SO-9718-96 →	MC
	128	200	30	12	SO-9718-128 →	MC



Stefano Orlati Handles

Bow Handles

	Centre (mm)	Length (mm)	Height (mm)	Width (mm)	Item number	Finish
9908 	96	105	30	13	SO-9908-96 →	BN
	128	147	30	14	SO-9908-128 →	BN
	96	105	30	13	SO-9908-96 →	CH
	128	147	30	14	SO-9908-128 →	CH
	96	105	30	13	SO-9908-96 →	MC
	128	147	30	14	SO-9908-128 →	MC
9910 	96	114	21	10	SO-9910-96 →	BN
	128	150	27	12	SO-9910-128 →	BN
	96	114	21	10	SO-9910-96 →	MC
	128	150	27	12	SO-9910-128 →	MC
211XL 	224	270	31	14	SO-211XL-224 →	BN
ARC 	128	153	31	10	SO-ARC-128 →	BN
	160	190	31	10	SO-ARC-160 →	BN
	224	263	31	10	SO-ARC-224 →	BN
	288	336	31	10	SO-ARC-288 →	BN

Stefano Orlati Handles

Bow Handles

	Centre (mm)	Length (mm)	Height (mm)	Width (mm)	Item number	Finish
C 	128	148	26	10	SO-C-128	BN
	160	180	26	10	SO-C-160	BN
	192	212	26	10	SO-C-192	BN
	128	148	26	10	SO-C-128	FS
	160	180	26	10	SO-C-160	FS
	192	212	26	10	SO-C-192	FS
	128	148	26	10	SO-C-128	MB
	160	180	26	10	SO-C-160	MB
	192	212	26	10	SO-C-192	MB
TSB 	96	111	29	10	SO-TSB-96	MB
	96	111	29	10	SO-TSB-96	BLKN
	128	150	30	10	SO-TSB-128	BLKN
	96	111	29	10	SO-TSB-96	BN
	128	150	30	10	SO-TSB-128	BN
	96	111	29	10	SO-TSB-96	CH
	128	150	30	10	SO-TSB-128	CH
	96	111	29	10	SO-TSB-96	MC
	128	150	30	10	SO-TSB-128	MC
	96	111	29	10	SO-TSB-96	SN
	128	150	30	10	SO-TSB-128	SN
	MJ001 	64	84	21	15	SO-MJ001-64

Profile Handles

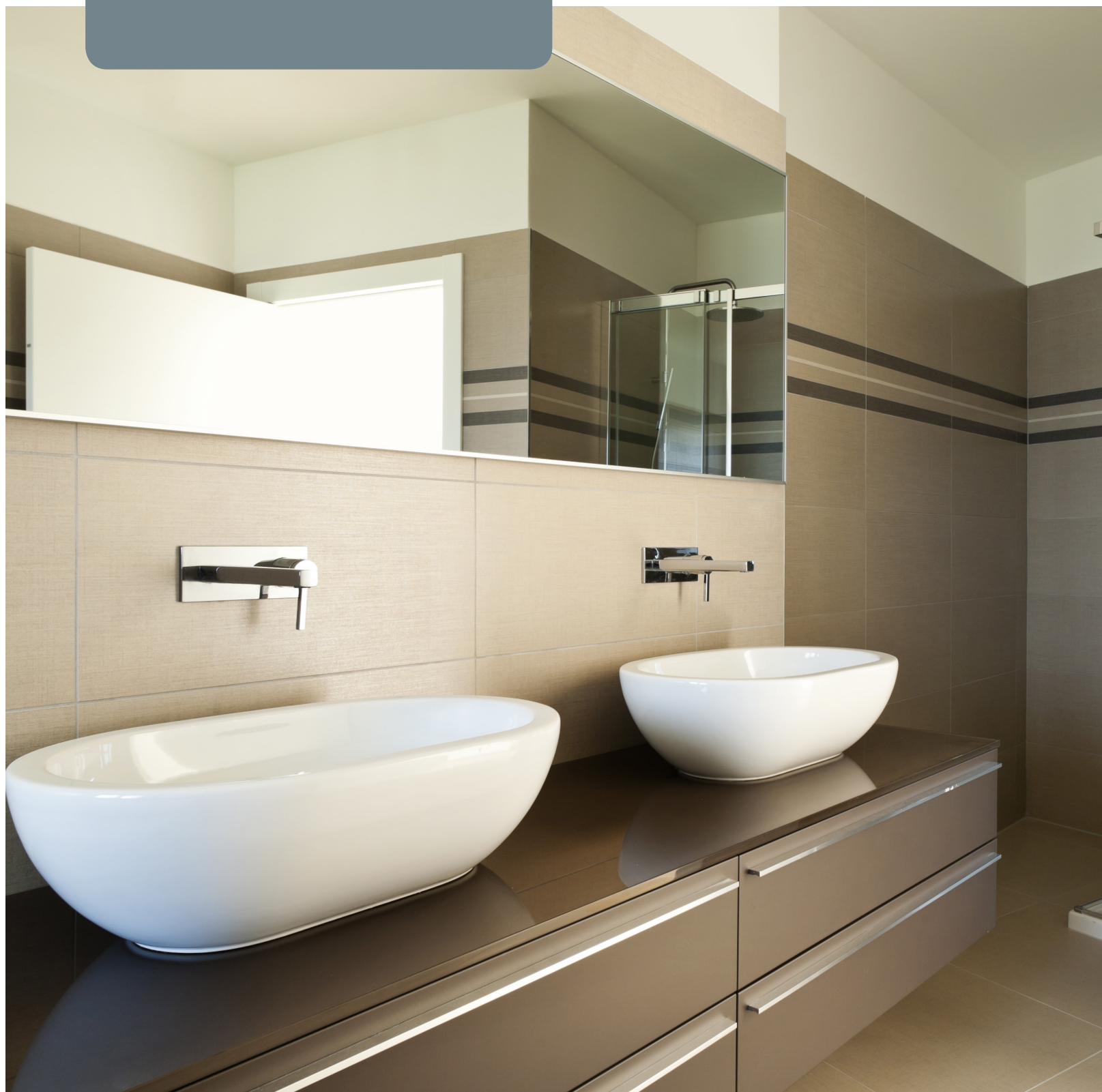

Stefano Orlati Handles

Profile Handles

	Length (mm)	Height (mm)	Width (mm)	Item number	Finish
AK0891   Side Profile	3000	35	16	SO-AK0891 →	FS
AK0891B   Side Profile	3000	35	18	SO-AK0891B →	FS
AK0894-NZ   Side Profile	5000	35	18	SO-AK0894-NZ →	FS

Stefano Orlati Handles

Profile Handles

- Create handleless openings for doors and top drawers
- Horizontal mounting
- Available in six on-trend finishes

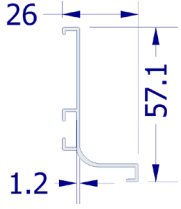
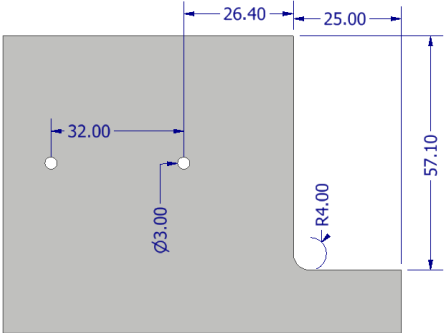
	Length (mm)	Height (mm)	Depth (mm)	Item number	Finish
CAPRI-J   	3600	57.1	26	608.8U10.360.001	FS
	3600	57.1	26	608.8U10.360.007	CH
	3600	57.1	26	608.8U10.360.010	MB
	3600	57.1	26	608.8U10.360.011	MW
	3600	57.1	26	608.8U10.360.013	TG
	3000	57.1	26	608.8U10.360.015	G
	· End caps and brackets ordered separately				
· Quoted dimensions consider that the CAPRI profile will have a 1mm overhang. Increase measurements by 1mm for applications where the CAPRI profile should be flush with the cabinet sides					

Stefano Orlati Handles

Profile Handles

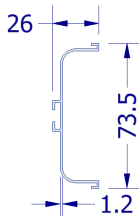
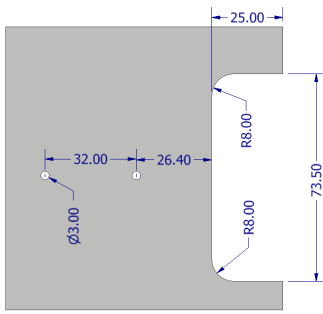
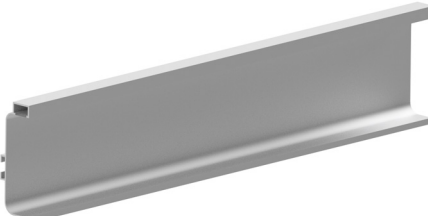
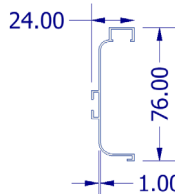
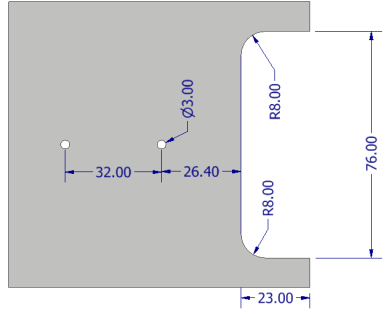

- Create handleless openings for drawers
- Horizontal mounting

	Length (mm)	Height (mm)	Depth (mm)	Item number	Finish
CAPRI-C   	3600	73.5	26	608.8U08.360.001	FS
	3600	73.5	26	608.8U08.360.007	CH
	3600	73.5	26	608.8U08.360.010	MB
	3600	73.5	26	608.8U08.360.011	MW
	3600	73.5	26	608.8U08.360.013	TG
	3000	73.5	26	608.8U08.360.015	G
<ul style="list-style-type: none"> · Available in six on-trend finishes · End caps and brackets ordered separately <p>· Quoted dimensions consider that the CAPRI profile will have a 1mm overhang. Increase measurements by 1mm for applications where the CAPRI profile should be flush with the cabinet sides</p>					
CAPRI-C LED   	3600	76	24	608.8U09.360.001	FS
	3600	76	24	608.8U09.360.007	CH
	3600	76	24	608.8U09.360.010	MB
	3600	76	24	608.8U09.360.011	MW
	3600	76	24	608.8U09.360.013	TG
	3000	76	24	608.8U09.360.015	G
<ul style="list-style-type: none"> · Integrated LED profile & strip · End caps and brackets ordered separately <p>· Quoted dimensions consider that the CAPRI profile will have a 1mm overhang. Increase measurements by 1mm for applications where the CAPRI profile should be flush with the cabinet sides</p>					

Stefano Orlati Handles

Profile Handles

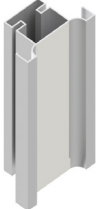
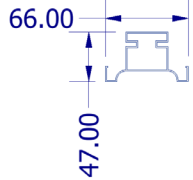
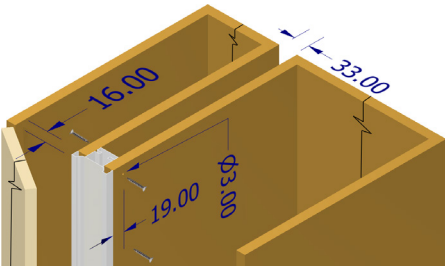
· Available in six on-trend finishes

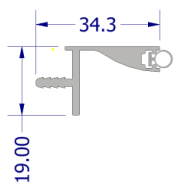
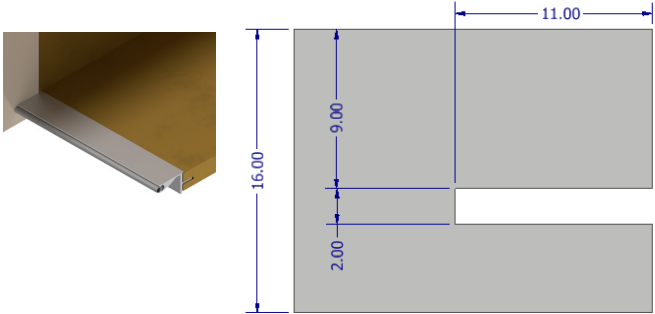
	Length (mm)	Height (mm)	Depth (mm)	Item number	Finish
CAPRI-Y   Side Profile 	2400	66	47	608.8U16.360.001	FS
	2400	66	47	608.8U16.360.007	CH
	2400	66	47	608.8U16.360.010	MB
	2400	66	47	608.8U16.360.011	MW
	2400	66	47	608.8U16.360.013	TG
	2400	66	47	608.8U16.360.015	G
· Create handleless openings for tower cabinets · Vertical mounting between cabinets					
CAPRI-R   Side Profile 	3600	19	34.3	608.8U14.360.001	FS
	3600	19	34.3	608.8U14.360.007	CH
	3600	19	34.3	608.8U14.360.010	MB
	3600	19	34.3	608.8U14.360.011	MW
	3600	19	34.3	608.8U14.360.013	TG
	3000	19	34.3	608.8U14.360.015	G
· Create handleless openings for wall cabinets · Horizontal mounting · Note: Can be used on 16mm and 18mm board. Dimensions are still 9mm from top to top of cutout					

Stefano Orlati Handles

Profile Handles

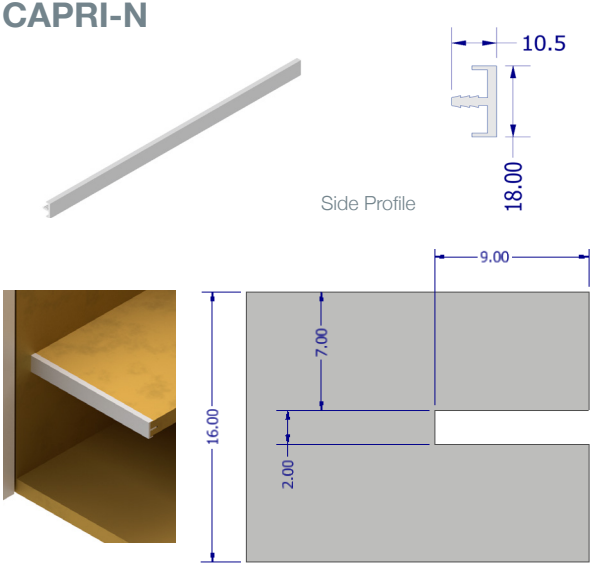
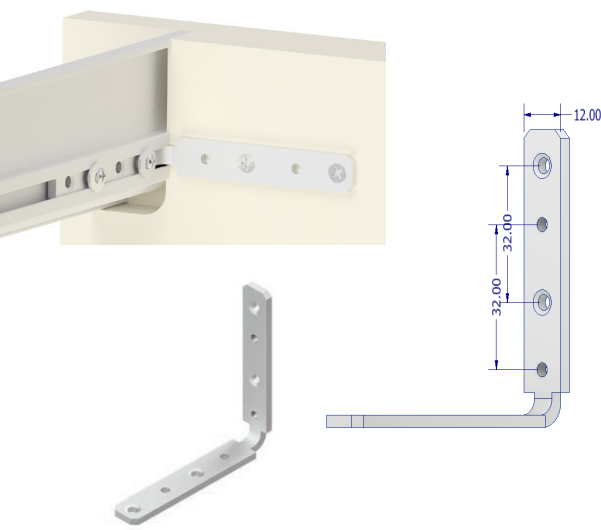
	Handing	Length (mm)	Height (mm)	Depth (mm)	Item number	Finish
<p>CAPRI-N</p> 		3600	18	10.5	608.8U12.360.001	FS
		3600	18	10.5	608.8U12.360.007	CH
		3600	18	10.5	608.8U12.360.010	MB
		3600	18	10.5	608.8U12.360.011	MW
		3600	18	10.5	608.8U12.360.013	TG
		3000	18	10.5	608.8U12.360.015	G
	<ul style="list-style-type: none"> · Shelf edge protection · Horizontal mounting · Available in six on-trend finishes <p>· Note: N Profile only suits 16mm board</p>					
<p>CAPRI Profile Mounting Bracket</p> 						
Universal					608.8U19.070.001	
<ul style="list-style-type: none"> · Universal mounting bracket for CAPRI Profile range · Simple 3 step mounting process 						

Stefano Orlati Handles

Profile Handles

	Handing	Item number	Finish	
CAPRI-J End Caps 	Left	608.8U17.056.001	FS	
	Right	608.8U17.057.001	FS	
	Left	608.8U17.056.007	CH	
	Right	608.8U17.057.007	CH	
	Left	608.8U17.056.010	MB	
	Right	608.8U17.057.010	MB	
	Left	608.8U17.056.011	MW	
	Right	608.8U17.057.011	MW	
	Left	608.8U17.056.013	TG	
	Right	608.8U17.057.013	TG	
	Left	608.8U17.056.015	G	
	Right	608.8U17.057.015	G	
	CAPRI-C End Caps 	Universal	608.8U17.073.001	FS
		Universal	608.8U17.073.007	CH
Universal		608.8U17.073.010	MB	
Universal		608.8U17.073.011	MW	
Universal		608.8U17.073.013	TG	
Universal		608.8U17.073.015	G	

Stefano Orlati Handles

Profile Handles

	Centre (mm)	Length (mm)	Height (mm)	Width (mm)	Item number	Finish	
R156   Side Profile	64	90	17	41	SO-R156-64 →	ABS	
	160	100	17	41	SO-R156-160 →	ABS	
	64	90	17	41	SO-R156-64 →	FS	
	160	100	17	41	SO-R156-160 →	FS	
· Mounts on top of panel edge							
PESARO PULL   Side Profile		200	18	36	SO-PP-200 →	ABS	
		200	18	36	SO-PP-200 →	FS	
		200	18	36	SO-PP-200 →	MB	
	2 screw holes - 40mm from edge						
		400	18	36	SO-PP-400 →	ABS	
		400	18	36	SO-PP-400 →	FS	
		400	18	36	SO-PP-400 →	MB	
	3 screw holes - 100mm between each hole & edge						
		600	18	36	SO-PP-600 →	ABS	
		600	18	36	SO-PP-600 →	FS	
		600	18	36	SO-PP-600 →	MB	
	4 screw holes - 120mm between each hole & edge						
		1250	18	26	SO-PP-1250 →	ABS	
	1250	18	26	SO-PP-1250 →	FS		
	1250	18	26	SO-PP-1250 →	MB		
Without holes drilled							
· Mounts on top of panel edge							

Stefano Orlati Handles

Profile Handles



	Centre (mm)	Length (mm)	Height (mm)	Width (mm)	Item number	Finish
548 	128	170	26	17	SO-548-128	ABS
	192	235	26	17	SO-548-192	ABS
	320	362	26	17	SO-548-320	ABS
	544	588	26	17	SO-548-544	ABS
	608	650	26	17	SO-548-608	ABS
	736	775	26	17	SO-548-736	ABS
	128	170	26	17	SO-548-128	MB
	192	235	26	17	SO-548-192	MB
	320	362	26	17	SO-548-320	MB
	544	588	26	17	SO-548-544	MB
	608	650	26	17	SO-548-608	MB
	736	775	26	17	SO-548-736	MB

Provincial Handles







Stefano Orlati Handles

Provincial Handles

	Centre (mm)	Length (mm)	Height (mm)	Width (mm)	Item number	Finish
1208 	96	132	29	14	SO-1186-96 →	BSAT
	96	204	29	16	SO-1186-96 →	BSBN
	Complimentary knob 1186K page → 42					
3440 	128	150	33	18	SO-3440-128 →	AC
	160	182	33	18	SO-3440-160 →	AC
	224	246	33	18	SO-3440-224 →	AC
	320	342	33	18	SO-3440-320 →	AC
	128	150	33	18	SO-3440-128 →	BN
	160	182	33	18	SO-3440-160 →	BN
	224	246	33	18	SO-3440-224 →	BN
	320	342	33	18	SO-3440-320 →	BN
	128	150	33	18	SO-3440-128 →	BSBN
	160	182	33	18	SO-3440-160 →	BSBN
	224	246	33	18	SO-3440-224 →	BSBN
	320	342	33	18	SO-3440-320 →	BSBN
	128	150	33	18	SO-3440-128 →	MAB
	160	182	33	18	SO-3440-160 →	MAB
	224	246	33	18	SO-3440-224 →	MAB
	320	342	33	18	SO-3440-320 →	MAB
Complimentary knob 3440K page → 48						

Stefano Orlati Handles

Provincial Handles

	Centre (mm)	Length (mm)	Height (mm)	Width (mm)	Item number	Finish
8391 	160	180	32	40	SO-8391-160 →	P
Complementary knob 3801 page → 49 Complementary knob 8393 page → 50						
8392 	128	188	28	21	SO-8392-128 →	P
Complementary knob 3801 page → 49 Complementary knob 8393 page → 50						
8407 	64	90	23	34	SO-8407-64 →	AB
	64	90	23	34	SO-8407-64 →	BN
	64	90	23	34	SO-8407-64 →	CH
Complementary knob 8741 page → 50						
8658 	96	132	25	16	SO-8658-96 →	AB
	96	132	25	16	SO-8658-96 →	BN
	96	132	25	16	SO-8658-96 →	CH
Complementary knob 8741 page → 50						

Stefano Orlati Handles

Provincial Handles

	Centre (mm)	Length (mm)	Height (mm)	Width (mm)	Item number	Finish
C15 	128	150	40	23	SO-C15-128 →	WHC/P
	Complementary knobs C10 and C14 page → 51					
1186 	96	132	29	14	SO-1186-96 →	BSAT
	160	204	29	16	SO-1186-160 →	BSAT
	96	132	29	14	SO-1186-96 →	BSBN
	160	204	29	16	SO-1186-160 →	BSBN
	Complimentary knob 1186K page → 48					

Recessed Handles



Stefano Orlati Handles

Recessed Handles

	Centre (mm)	Length (mm)	Height (mm)	Width (mm)	Item number	Finish
1159 	35		7	40	SO-1159 →	BN
709 	128	138	13	30	SO-709-128 →	S
	<ul style="list-style-type: none"> · Suit minimum 16mm board · Recess depth 10mm 					
AHS403 	128	145	16	42	SO-AHS403-128 →	ABS
	160	172	16	42	SO-AHS403-160 →	ABS
	128	145	16	42	SO-AHS403-128 →	FS
	160	172	16	42	SO-AHS403-160 →	FS
	<ul style="list-style-type: none"> · Suit minimum 16mm board · Recess depth 14mm · ABS in this range is a dark version of the ABS finish 					
MH20 	127	170	18	40	SO-MH20-127 →	S
	226	330	18	40	SO-MH20-226 →	S
	<ul style="list-style-type: none"> · Suit minimum 18mm board · Recess depth 15mm 					

Square Handles





Stefano Orlati Handles

Square Handles

	Centre (mm)	Length (mm)	Height (mm)	Width (mm)	Item number	Finish
116 	128	159	29	15	SO-116-128 →	BN
	160	190	29	15	SO-116-160 →	BN
	128	159	29	15	SO-116-128 →	MC
	160	190	29	15	SO-116-160 →	MC
288 	16	80	36	16	SO-288-16 →	BN
	96	109	36	16	SO-288-96 →	BN
	128	141	36	16	SO-288-128 →	BN
	160	173	36	16	SO-288-160 →	BN
	224	237	36	16	SO-288-224 →	BN
	288	301	36	16	SO-288-288 →	BN
298 	64	78	32	15	SO-298-64 →	BN
	128	142	32	15	SO-298-128 →	BN
	256	270	32	15	SO-298-256 →	BN
	64	78	32	15	SO-298-64 →	CH
	128	142	32	15	SO-298-128 →	CH
	256	270	32	15	SO-298-256 →	CH
	64	78	32	15	SO-298-64 →	MC
	128	142	32	15	SO-298-128 →	MC
	256	270	32	15	SO-298-256 →	MC

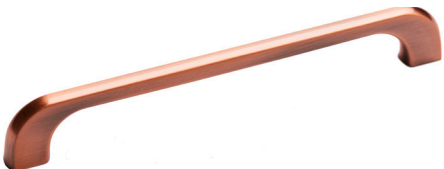

Stefano Orlati Handles

Square Handles

	Centre (mm)	Length (mm)	Height (mm)	Width (mm)	Item number	Finish
305 	128	145	25	12	SO-305-128 →	AC
	160	177	25	12	SO-305-160 →	AC
	224	241	27	12	SO-305-224 →	AC
	320	337	27	12	SO-305-320 →	AC
	128	145	25	12	SO-305-128 →	AI
	160	177	25	12	SO-305-160 →	AI
	224	241	27	12	SO-305-224 →	AI
	320	337	27	12	SO-305-320 →	AI
	128	145	25	12	SO-305-128 →	BN
	160	177	25	12	SO-305-160 →	BN
	224	241	27	12	SO-305-224 →	BN
	320	337	27	12	SO-305-320 →	BN
	128	145	25	12	SO-305-128 →	MC
	160	177	25	12	SO-305-160 →	MC
	224	241	27	12	SO-305-224 →	MC
	320	337	27	12	SO-305-320 →	MC
690 	64	83	18	11	SO-690-64 →	CH
	64	83	18	11	SO-690-64 →	MC

Stefano Orlati Handles

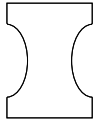
Square Handles

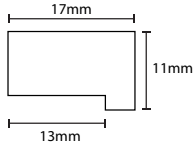
	Centre (mm)	Length (mm)	Height (mm)	Width (mm)	Item number	Finish
809   Side Profile	16	28	18	12	SO-809-16	BN
	96	108	18	12	SO-809-96	BN
	160	178	18	12	SO-809-160	BN
	256	274	20	12	SO-809-256	BN
	16	28	18	12	SO-809-16	CH
	96	108	18	12	SO-809-96	CH
	160	178	18	12	SO-809-160	CH
	256	274	20	12	SO-809-256	CH
Complementary knob 809 page → 46						
274   Side Profile	96	120	18	11	SO-274-96	CH
	96	120	18	11	SO-274-96	FS
	128	150	18	11	SO-274-128	FS
	192	245	18	11	SO-274-192	FS
	288	330	18	11	SO-274-288	FS
	576	628	18	11	SO-274-576	FS
	736	757	18	11	SO-274-736	FS
	864	914	18	11	SO-274-864	FS
1000	1000	18	11	SO-274-1000	FS	

Stefano Orlati Handles

Square Handles

	Centre (mm)	Length (mm)	Height (mm)	Width (mm)	Item number	Finish
1092 	96	102	27	11	SO-1092-96 →	MB
	128	134	27	11	SO-1092-128 →	MB
	160	166	27	11	SO-1092-160 →	MB
	224	230	27	11	SO-1092-224 →	MB
	288	294	27	11	SO-1092-288 →	MB
	320	326	27	11	SO-1092-320 →	MB
	96	102	27	11	SO-1092-96 →	BN
	128	134	27	11	SO-1092-128 →	BN
	160	166	27	11	SO-1092-160 →	BN
	224	230	27	11	SO-1092-224 →	BN
	288	294	27	11	SO-1092-288 →	BN
	320	326	27	11	SO-1092-320 →	BN
	96	102	27	11	SO-1092-96 →	CH
	128	134	27	11	SO-1092-128 →	CH
	160	166	27	11	SO-1092-160 →	CH
	224	230	27	11	SO-1092-224 →	CH
	288	294	27	11	SO-1092-288 →	CH
	320	326	27	11	SO-1092-320 →	CH
	96	102	27	11	SO-1092-96 →	MC
	128	134	27	11	SO-1092-128 →	MC
	160	166	27	11	SO-1092-160 →	MC
	224	230	27	11	SO-1092-224 →	MC
	288	294	27	11	SO-1092-288 →	MC
	320	326	27	11	SO-1092-320 →	MC

Stefano Orlati Handles

Square Handles

	Centre (mm)	Length (mm)	Height (mm)	Width (mm)	Item number	Finish
1745 	128	137	28	21	SO-1745-128 →	BN
	192	201	28	21	SO-1745-192 →	BN
	256	265	28	21	SO-1745-256 →	BN
	128	137	28	21	SO-1745-128 →	MC
	192	201	28	21	SO-1745-192 →	MC
	256	265	28	21	SO-1745-256 →	MC
	128	137	28	21	SO-1745-128 →	SC
	192	201	28	21	SO-1745-192 →	SC
	256	265	28	21	SO-1745-256 →	SC
3061 	128	158	25	20	SO-3061-128 →	BN
	192	226	27	24	SO-3061-192 →	BN
	128	158	25	20	SO-3061-128 →	MC
	192	226	27	24	SO-3061-192 →	MC

Stefano Orlati Handles

Square Handles

	Centre (mm)	Length (mm)	Height (mm)	Width (mm)	Item number	Finish
3064 	128	157	27	8	SO-3064-128 →	PB
	160	192	27	8	SO-3064-160 →	PB
	128	157	27	8	SO-3064-128 →	SB
	160	192	27	8	SO-3064-160 →	SB
	96	121	27	8	SO-3064-96 →	BN
	128	157	27	8	SO-3064-128 →	BN
	160	192	27	8	SO-3064-160 →	BN
	192	224	27	8	SO-3064-192 →	BN
	240	273	27	8	SO-3064-240 →	BN
	320	355	27	8	SO-3064-320 →	BN
	96	121	27	8	SO-3064-96 →	MC
	128	157	27	8	SO-3064-128 →	MC
	160	192	27	8	SO-3064-160 →	MC
	192	224	27	8	SO-3064-192 →	MC
	240	273	27	8	SO-3064-240 →	MC
	320	355	27	8	SO-3064-320 →	MC

Stefano Orlati Handles

Square Handles

	Centre (mm)	Length (mm)	Height (mm)	Width (mm)	Item number	Finish
4062 	96	104	28.3	8.3	SO-4062-96 →	MB
	128	136	28.3	8.3	SO-4062-128 →	MB
	160	168	28.3	8.3	SO-4062-160 →	MB
	192	200	28.3	8.3	SO-4062-192 →	MB
	256	264	28.3	8.3	SO-4062-256 →	MB
	320	328	28.3	8.3	SO-4062-320 →	MB
	416	424	28.3	8.3	SO-4062-416 →	MB
	96	104	28.3	8.3	SO-4062-96 →	BN
	128	136	28.3	8.3	SO-4062-128 →	BN
	160	168	28.3	8.3	SO-4062-160 →	BN
	192	200	28.3	8.3	SO-4062-192 →	BN
	256	264	28.3	8.3	SO-4062-256 →	BN
	320	328	28.3	8.3	SO-4062-320 →	BN
	416	424	28.3	8.3	SO-4062-416 →	BN
	96	104	28.3	8.3	SO-4062-96 →	TG
	128	136	28.3	8.3	SO-4062-128 →	TG
	160	168	28.3	8.3	SO-4062-160 →	TG
	192	200	28.3	8.3	SO-4062-192 →	TG
	256	264	28.3	8.3	SO-4062-256 →	TG
	320	328	28.3	8.3	SO-4062-320 →	TG
	416	424	28.3	8.3	SO-4062-416 →	TG

Stefano Orlati Handles

Square Handles

	Centre (mm)	Length (mm)	Height (mm)	Width (mm)	Item number	Finish
5075	128	142	22	14	SO-5075-128 →	MBN
	192	206	22	14	SO-5075-192 →	MBN
	320	334	22	14	SO-5075-320 →	MBN
	128	142	22	14	SO-5075-128 →	CH
	192	206	22	14	SO-5075-192 →	CH
	320	334	22	14	SO-5075-320 →	CH
	128	142	22	14	SO-5075-128 →	SB
	192	206	22	14	SO-5075-192 →	SB
	320	334	22	14	SO-5075-320 →	SB
	128	142	22	14	SO-5075-128 →	TG
	192	206	22	14	SO-5075-192 →	TG
	320	334	22	14	SO-5075-320 →	TG



Stefano Orlati Handles

Square Handles

	Centre (mm)	Length (mm)	Height (mm)	Width (mm)	Item number	Finish
5076 	128	138	29	10	SO-5076-128 →	CH
	192	202	29	10	SO-5076-192 →	CH
	256	266	29	10	SO-5076-256 →	CH
	320	330	29	10	SO-5076-320 →	CH
	128	138	29	10	SO-5076-128 →	MB
	192	202	29	10	SO-5076-192 →	MB
	256	266	29	10	SO-5076-256 →	MB
	320	330	29	10	SO-5076-320 →	MB
	128	138	29	10	SO-5076-128 →	BN
	192	202	29	10	SO-5076-192 →	BN
	256	266	29	10	SO-5076-256 →	BN
	320	330	29	10	SO-5076-320 →	BN
6330 	128	142	30	25	SO-6330-128 →	BN
	192	206	30	25	SO-6330-192 →	BN
	256	269	30	25	SO-6330-256 →	BN
	320	334	30	25	SO-6330-320 →	BN
	544	558	30	25	SO-6330-544 →	BN



Stefano Orlati Handles

Square Handles

	Centre (mm)	Length (mm)	Height (mm)	Width (mm)	Item number	Finish
8230 	128	192	30	10	SO-8230-128 →	ABS
	192	256	30	10	SO-8230-192 →	ABS
	320	384	30	10	SO-8230-320 →	ABS
	480	544	30	10	SO-8230-480 →	ABS
8513 	128	150	40	13	SO-8513-128 →	SS
	160	182	40	13	SO-8513-160 →	SS
	192	214	40	13	SO-8513-192 →	SS
	224	246	40	13	SO-8513-224 →	SS
	352	375	40	13	SO-8513-352 →	SS
	554	576	40	13	SO-8513-554 →	SS
8645 	160	250	30	7	SO-8645-160 →	ABS
	160	250	30	7	SO-8645-160 →	CH
	160	250	30	7	SO-8645-160 →	FS
8650 	160	250	30	7	SO-8650-160 →	ABS
	160	250	30	7	SO-8650-160 →	CH



Stefano Orlati Handles

Square Handles

	Centre (mm)	Length (mm)	Height (mm)	Width (mm)	Item number	Finish
A 	128	135	30	12	SO-A-128	MB
	160	167	30	12	SO-A-160	MB
	224	231	30	12	SO-A-224	MB
	320	327	30	12	SO-A-320	MB
	128	135	30	12	SO-A-128	BN
	160	167	30	12	SO-A-160	BN
	224	231	30	12	SO-A-224	BN
	320	327	30	12	SO-A-320	BN
	128	135	30	12	SO-A-128	FS
	160	167	30	12	SO-A-160	FS
	224	231	30	12	SO-A-224	FS
	320	327	30	12	SO-A-320	FS
B 	128	135	30	12	SO-B-128	MB
	160	167	30	12	SO-B-160	MB
	224	231	30	12	SO-B-224	MB
	320	327	30	12	SO-B-320	MB
	128	135	30	12	SO-B-128	BN
	160	167	30	12	SO-B-160	BN
	224	231	30	12	SO-B-224	BN
	320	327	30	12	SO-B-320	BN
	128	135	30	12	SO-B-128	FS
	160	167	30	12	SO-B-160	FS
	224	231	30	12	SO-B-224	FS
	320	327	30	12	SO-B-320	FS

Stefano Orlati Handles

Square Handles

	Centre (mm)	Length (mm)	Height (mm)	Width (mm)	Item number	Finish
D 	96	106	37	10	SO-D-96	BN
	128	138	37	10	SO-D-128	BN
	128	138	37	10	SO-D-128	MC
MH14 	64	78	29	7	SO-MH14-64	BN
	96	110	29	7	SO-MH14-96	BN
	128	141	29	7	SO-MH14-128	BN
	224	238	29	7	SO-MH14-224	BN
	320	333	29	7	SO-MH14-320	BN
	64	78	29	7	SO-MH14-64	CH
	96	110	29	7	SO-MH14-96	CH
	128	141	29	7	SO-MH14-128	CH
	224	238	29	7	SO-MH14-224	CH
	320	333	29	7	SO-MH14-320	CH
	64	78	29	7	SO-MH14-64	S
	96	110	29	7	SO-MH14-96	S
	128	141	29	7	SO-MH14-128	S
	224	238	29	7	SO-MH14-224	S
320	333	29	7	SO-MH14-320	S	
OK90 	128	149	24	7	SO-OK90-128	MC

Stainless Steel Handles



Stefano Orlati Handles

Stainless Steel Handles

	Centre (mm)	Length (mm)	Height (mm)	Width (mm)	Item number	Finish
909 	128	142	40	14	SO-909-128 →	SS
	160	174	40	14	SO-909-160 →	SS
	224	238	40	14	SO-909-224 →	SS
	320	334	40	14	SO-909-320 →	SS
	480	494	40	14	SO-909-480 →	SS
6820 	128	136	31	21	SO-6820-128 →	SS
	160	168	31	21	SO-6820-160 →	SS
	224	232	31	21	SO-6820-224 →	SS
	320	328	31	21	SO-6820-320 →	SS
	448	456	31	21	SO-6820-448 →	SS
8721 	128	138	33	19	SO-8721-128 →	SS
	160	170	33	19	SO-8721-160 →	SS
	192	202	33	19	SO-8721-192 →	SS
	224	234	33	19	SO-8721-224 →	SS
	320	330	33	19	SO-8721-320 →	SS
	448	458	33	19	SO-8721-448 →	SS

Stefano Orlati Handles

Stainless Steel Handles



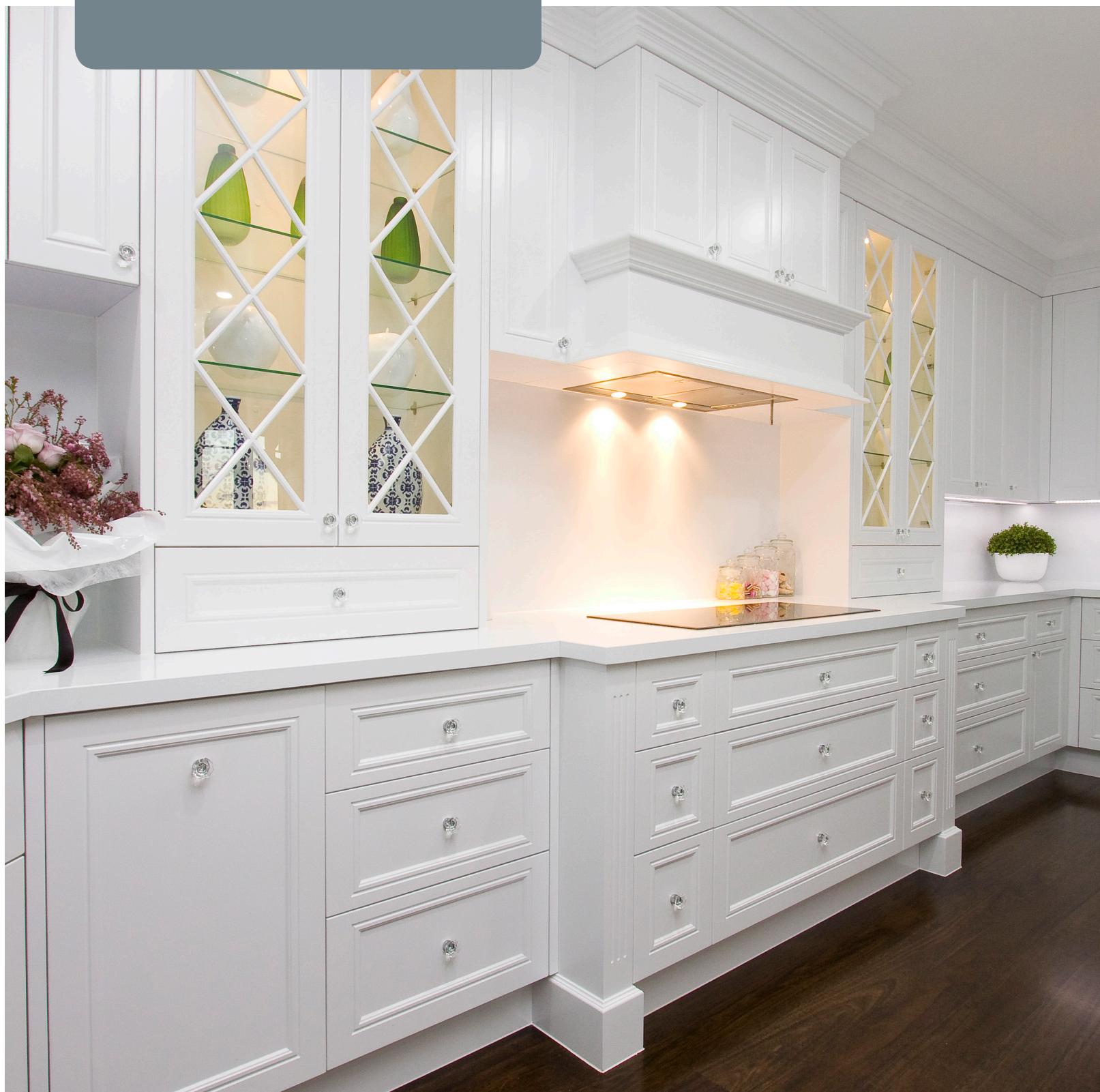

	Centre (mm)	Length (mm)	Height (mm)	Width (mm)	Item number	Finish
SSD 	128	138	33	10	SO-SSD-128 →	SS
	160	170	33	10	SO-SSD-160 →	SS
	192	202	33	10	SO-SSD-192 →	SS
	288	298	33	10	SO-SSD-288 →	SS
	352	362	33	10	SO-SSD-352 →	SS
	448	458	33	10	SO-SSD-448 →	SS
SSTB 	96	136	34	12	SO-SSTB-96 →	SS
	128	168	34	12	SO-SSTB-128 →	SS
	160	200	34	12	SO-SSTB-160 →	SS
	192	232	34	12	SO-SSTB-192 →	SS
	288	328	34	12	SO-SSTB-288 →	SS
	352	392	34	12	SO-SSTB-352 →	SS
	448	488	34	12	SO-SSTB-448 →	SS
	544	584	34	12	SO-SSTB-544 →	SS

Knobs





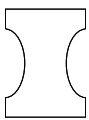

Stefano Orlati Handles

Knobs

	Centre (mm)	Length (mm)	Height (mm)	Width (mm)	Item number	Finish
139 	K		27	29	SO-139-K →	BN
	K		27	29	SO-139-K →	CH
	K		27	29	SO-139-K →	MC
288 	16	80	36	16	SO-288-K →	BN
	16	80	36	16	SO-288-K →	FS
809K   <p>Side Profile</p>	16	28	18	12	SO-809-16 →	BN
	16	28	18	12	SO-809-16 →	CH
Complementary handles 809 page → 32						
1112 	16	25	27	21	SO-1112-16 →	BN
	16	25	27	21	SO-1112-16 →	CH
	16	25	27	21	SO-1112-16 →	MC



Stefano Orlati Handles

Knobs

	Centre (mm)	Length (mm)	Height (mm)	Width (mm)	Item number	Finish
1160 	K		26	17	SO-1160Small-K →	BN
	K		28	25	SO-1160Large-K →	BN
	K		26	17	SO-1160Small-K →	MC
	K		28	25	SO-1160Large-K →	MC
1172 	K		19	14	SO-1172-K →	MB
1179 	K	22	28	22	SO-1179-K →	BN
1186K 	K	38	25	19	SO-1186-K →	BSAT
	K	38	25	19	SO-1186-K →	BSBN
Complementary handles 1208 page → 24 Complementary handles 1186 page → 26						



Stefano Orlati Handles

Knobs

	Centre (mm)	Length (mm)	Height (mm)	Width (mm)	Item number	Finish
3318 	16	39	18	21	SO-3318-16 →	CH
	16	39	18	21	SO-3318-16 →	MC
3320 	K		28	33	SO-3320-K →	BN
3321 	K		26	27	SO-3321-K →	BN
	K		26	27	SO-3321-K →	MC
3440K 	K	21	33	18	SO-3440-K →	AC
	K	21	33	18	SO-3440-K →	BN
	K	21	33	18	SO-3440-K →	BSBN
	K	21	33	18	SO-3440-K →	MAB
Complementary handles 3440 page → 24						

Stefano Orlati Handles

Knobs

	Centre (mm)	Length (mm)	Height (mm)	Width (mm)	Item number	Finish
3590 	K		24	15	SO-3590-K →	FS
3801 	K	33	25	33	SO-3801-K →	AB
	K	33	25	33	SO-3801-K →	BN
	K	33	25	33	SO-3801-K →	CH
	K	33	25	33	SO-3801-K →	P
	K	33	25	33	SO-3801-K →	MB
	Complementary handles 8391 page → 25 Complementary handles 8392 page → 25					
MJ002 	K	52	18	9	SO-MJ002-K →	SN
MJ003 	K	30	25	30	SO-MJ003-K →	P





Stefano Orlati Handles

Knobs

	Centre (mm)	Length (mm)	Height (mm)	Width (mm)	Item number	Finish
8047 	K	38	31	38	SO-8047-K →	BN
	K	38	31	38	SO-8047-K →	MC
8393 	K	64	32	22	SO-8393-K →	P
	Complementary handles 8391 page → 20 Complementary handles 8392 page → 20					
8741 	K	33	28	33	SO-8741-K →	BN
	K	33	28	33	SO-8741-K →	CH
	K	33	28	33	SO-8741-K →	AB
Complementary handle 8658 page → 20 Complementary handle 8407 page → 20						
9909 	K	45		45	SO-9909-K →	MB

Stefano Orlati Handles

Knobs

	Centre (mm)	Length (mm)	Height (mm)	Width (mm)	Item number	Finish
C10 	K	30	30	30	SO-C10-K →	P/W
Complementary handles C15 page → 26						
C14 	K	75	35	23	SO-C14-K →	P/W
Complementary handles C15 page → 26						
GL02 	K	35	28	35	SO-GL02-K →	CL/CH
Complementary handles C15 page → 26						
GL03 	K	35	32	35	SO-GL03-K →	CL/CH
Complementary handles C15 page → 26						

Stefano Orlati

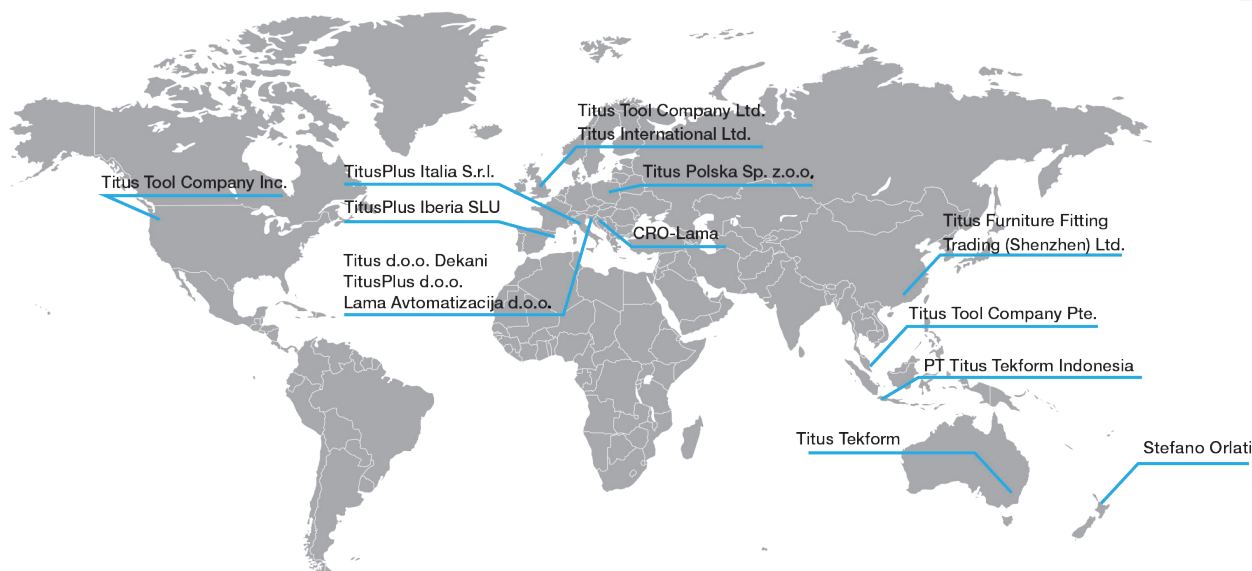

Auckland:

Stefano Orlati Pty Ltd
34 Waipareira Avenue
Henderson, Auckland, 0610
T: +64 9 837 0886
Fax: +64 837 8003

Christchurch:

Stefano Orlati Pty Ltd
162 Wordsworth Street
Sydenham, Christchurch, 8023
T: +64 3 981 8518
Fax: +64 3 942 7296





Titus Tekform Australia

www.titustekform.com.au
info@titustekform.com.au

Stefano Orlati New Zealand

www.stefano-orlati.com
stefano-orlati@titusplus.com

Connect with us

-  [LinkedIn.com/company/titustekform](https://www.linkedin.com/company/titustekform)
-  [Instagram.com/titustekform](https://www.instagram.com/titustekform)
-  [Pinterest.com/titustekform](https://www.pinterest.com/titustekform)
-  "Titus Tekform"